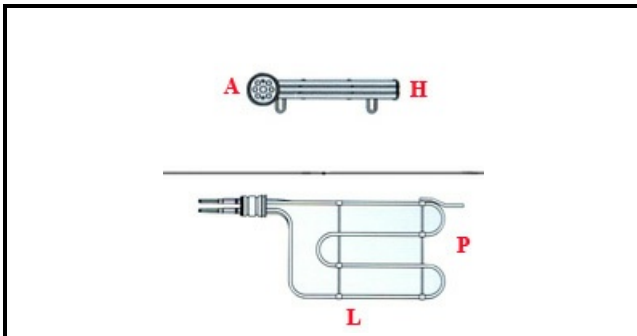

1101030

**RESISTENZA C.PASTA 8,5KW 230V**

Data: 23-11-2024

ORIGINAL  
**OSP**  
SPARE PARTS**Dati tecnici**

LUNGHEZZA MM	L=410mm
LARGHEZZA MM	P=220mm
NR ELEMENTI	ELEMENTI/ELEMENTS=3
FLANGIA TONDA	TONDA/ROUND FLANGE=40mm
DIAMETRO mm	A=40mm
KILOWATT KW	KW=8,5
WATT	W=8500
TRIFASE	TRIFASE/THREEPHASE
FILETTO GAS	1"1/4
NUMERO POLI	POLI/POLES=6
GUARNIZIONE	2101569
RESISTENZE PER IMMERSIONE	IMMERSIONE/IMMERSION
FLANGIA FILETTATA	1"1/4

**Codici produttore**

SILKO ALI GROUP SRL A SOCIO UNICO

MARENO ALI GROUP SRL A SOCIO UNICO