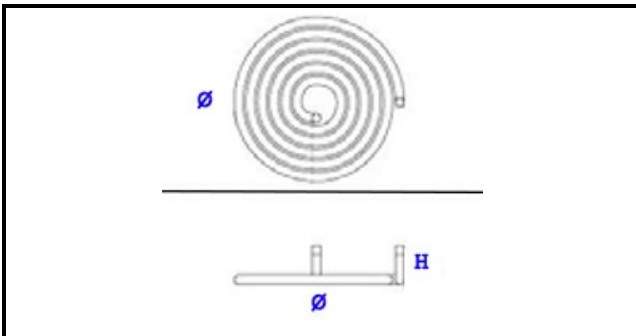

1101684

RESISTENZA W.3600 V.400 X P.D.450

Data: 22-11-2024

ORIGINAL
OSP
SPARE PARTS**Dati tecnici**

NR ELEMENTI	ELEMENTI/ELEMENTS=1
DIAMETRO mm	Ø=450mm
KILOWATT KW	KW=3.6
WATT	WATT=3600
TRIFASE	TRIFASE/THREEPHASE
NUMERO POLI	POLI/POLES=2
RESISTENZE A SECCO	SECCO/DRY

Codici produttore

OEM - ALI GROUP SRL A SOCIO UNICO