

1106475

KIT TERMOSTATO 360° MONOFASE SICUREZZA CAMERA F2 - SENSORE Ø14X12 mm CAPILLARE 880mm

Data: 22-11-2024



Dati tecnici

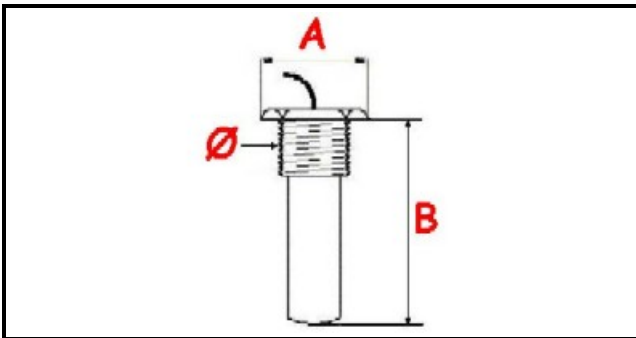

MONOFASE	MONOFASE/MONOPHASE
FILETTO GAS	Ø=14mm
TEMPERATURA MASSIMA °	T max=360°
CAPILLARE mm	L=880mm
SENSORE DIAMETRO MM	A=25mm
SENSORE LUNGHEZZA MM	B=12mm

Codici produttore

LAINOX ALI GROUP SRL A SOCIO UNICO
OLIS ALI GROUP SRL A SOCIO UNICO
LAINOX ALI GROUP SRL A SOCIO UNICO